

For Low Pressure

Micro Cupla

For piping in pneumatic control devices

Working pressure



Valve structure



Applicable fluids



Compact, lightweight Cuplas with only 9.5mm outer diameter.
Push-to-connect operation. Tube Fitter type for even easier tube insertion.

- Even though the valve is built in the socket, the sleeve outer diameter is confined to 9.5mm.
- Push-to-connect design.
- Just push in and the tube mount is completed.
- Compact design for piping in narrow spaces.
- Plated brass and stainless steel bodies are available for excellent corrosion resistance.
- Available in various end configurations to satisfy a wide range of pneumatic applications.

Note: Fluid will flow out from the plug when disconnected because of no valve inside the plug.
 If the fluid is water and you require a valve in the plug, ask for semi-standard Little Cupla or Compact Cupla series.

Stainless steel models added to the product lineup.

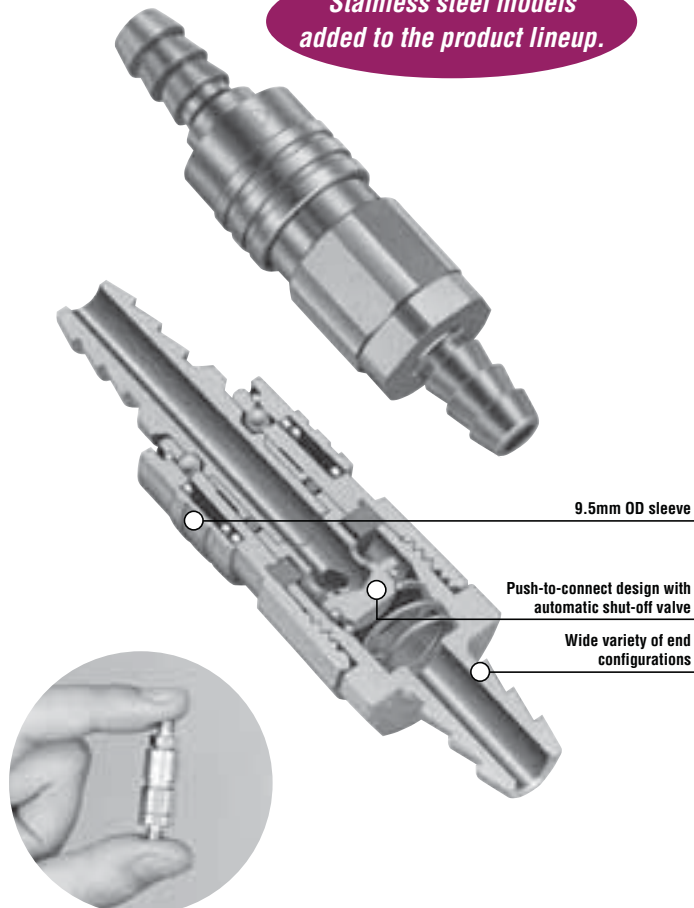

Specifications

Body material	Cupla : Brass (Plated) • Stainless steel (SUS 304) Tube Fitter Type : Brass (Chrome-plated)			
Size	1/8" (Minimum internal diameter 2.5mm) *Minimum internal diameter of MC-03SP : 1.2mm			
Tube size (for Tube Fitter end configurations)	Polyurethane : $\phi 4 \pm 0.1$ • $\phi 6 \pm 0.1$ Nylon : $\phi 4^{+0.05}_{-0.08}$ • $\phi 6^{+0.05}_{-0.08}$ Teflon : $\phi 4 \pm 0.05$ • $\phi 6 \pm 0.07$			
Working pressure MPa (kgf/cm ²)	1.0 (10)			
Pressure resistance MPa (kgf/cm ²)	1.5 (15)			
Seal material Working temperature range	Seal material	Mark	Working temperature range	Remarks
	Nitrile rubber	NBR (SG)	-20°C~+80°C	Standard material
	Fluoro rubber	FKM (X-100)	-20°C~+180°C	Made-to-order item(s)

* Above specifications apply only to Cuplas. Working pressure, pressure resistance and working temperature range may vary depending on tube materials you use with and temperature conditions you use under. Micro Cupla with Tube Fitter has NBR packing material only.

Max. Tightening Torque

N•m (kgf•cm)

Size	M5 x 0.8	1/8"
Torque	1.3 (13)	7 (71)

Flow Direction

Air flows in either direction from plug or socket side when coupled.



Interchangeability

Sockets and plugs can be connected regardless of end configurations.

Min. Cross-Sectional Area

(mm²)

Model	MC-03SP	MC-04SP	MC-05SP	MC-10SP	Tube Fitter Type for 4mm OD tube	Tube Fitter Type for 6mm OD tube
Min. cross-sectional area	1.1	4.9	4.9	4.9	4.9	4.9

Suitability for Vacuum

53.0kPa (400mmHg)

Socket only	Plug only	When connected
—	—	Operational

Pressure - Flow Characteristics

[Test conditions] • Fluid : Air • Temperature : Room temperature
 • Tube size : $\phi 4\text{mm} \times \phi 2\text{mm}$, $\phi 6\text{mm} \times \phi 4\text{mm}$ (Micro Cupla with Tube Fitter)

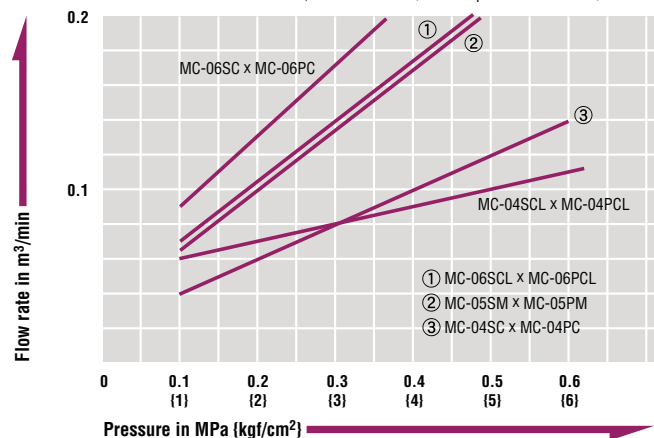

Models and Dimensions

Plug PH type (Hose barb)

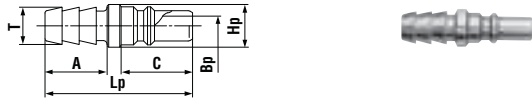

Model	Application (Tube)	Body material*Mass (g)	Dimensions (mm)					
		Brass	Lp	C	A	øHp	øT	øBp
MC-03PH	3mm ID	1.2	19	9.2	8	5.5	3.5	1.2
MC-04PH	4mm ID	1.4	19	9.2	8	5.5	4.8	2.5

Plug PM type (Male thread)



Model	Application	Body material*Mass (g)	Dimensions (mm)					
		Brass	Lp	C	A	Hp(WAF)	T	øBp
MC-05PM	M5 x 0.8	1.9	17	9.2	4.5	Hex.7	M5x0.8	2.5

Plug PM type (Male thread)



Model	Application	Body material*Mass (g)	Dimensions (mm)					
		Brass	Lp	C	Hp(WAF)	T	øBp	
MC-10PM	Rc1/8	9	26	9.2	Hex.11	R1/8	2.5	

Plug PHL type (L-shaped hose barb)

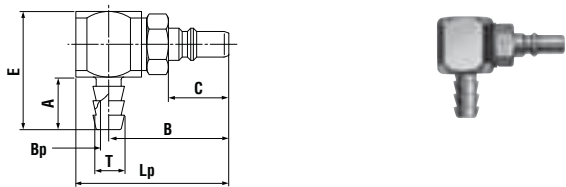

Model	Application (Tube)	Body material*Mass (g)	Dimensions (mm)						
		Brass	Lp	C	A	B	E	øT	øBp
MC-04PHL	4mm ID	9.4	(23.3)	9.2	8	(18.3)	18	4.8	2.5

Application Example

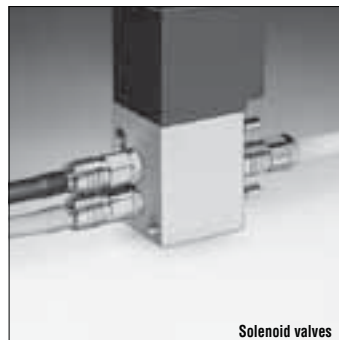

Socket SH type (Hose barb)

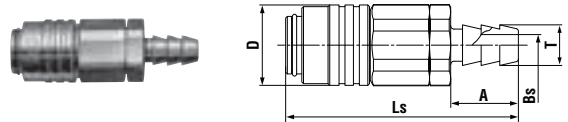

Model	Application (Tube)	Body material*Mass (g)	Dimensions (mm)				
		Brass	Ls	øD	A	øT	øBs
MC-03SH	3mm ID	7	(27.5)	9.5	8	3.5	1.2
MC-04SH	4mm ID	7.3	(27.5)	9.5	8	4.8	2.5

Socket SM type (Male thread)

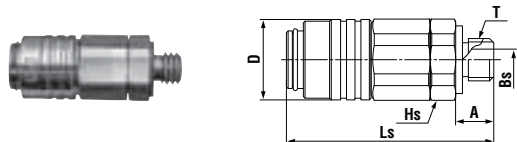

Model	Application	Body material*Mass (g)	Dimensions (mm)					
		Brass	Ls	øD	A	T	Hs(WAF)	øBs
MC-05SM	M5 x 0.8	7.4	(24.5)	9.5	4.5	M5x0.8	Hex.9	2.5

Socket SM type (Male thread)

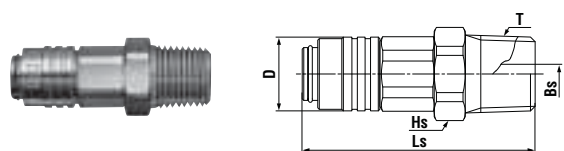

Model	Application	Body material*Mass (g)	Dimensions (mm)					
		Brass	Ls	øD	T	Hs(WAF)	øBs	
MC-10SM	Rc1/8	13.1	(30)	9.5	R1/8	Hex.11	3	

Socket SHL type (L-shaped hose barb)

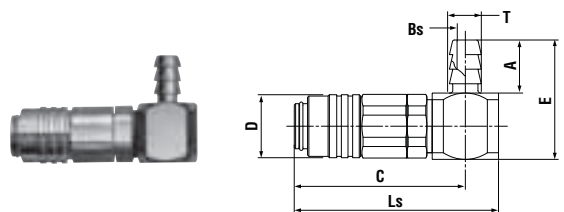

Model	Application (Tube)	Body material*Mass (g)	Dimensions (mm)						
		Brass	Ls	C	E	A	øD	øT	øBs
MC-04SHL	4mm ID	14.8	(30.8)	(25.8)	18	8	9.5	4.8	2.5

Socket SHB type (For panel mounting)

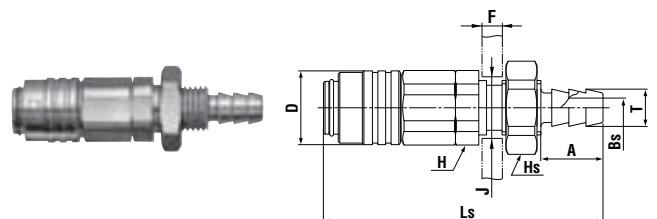

* F and øJ are dimensions of panel.

Model	Application (Tube)	Body material*Mass (g)	Dimensions (mm)								
		Brass	Ls	A	øD	øT	øBs	Hs(WAF)	øJ	H(WAF)	F
MC-04SHB	4mm ID	11.5	(36)	8	9.5	4.8	2.5	Hex.11	7.1 ^{+0.3}	Hex.9	1.2~3.5

Plug PC type (With Tube Fitter)



Model	Application (Tube)	Mass (g)	Dimensions (mm)			
			Lp	C	øT	øBp
MC-04PC	4mm OD	3	(21.7)	9.2	8	2.5
MC-06PC	6mm OD	5	(25)	9.2	9.8	2.5

Socket SC type (With Tube Fitter)

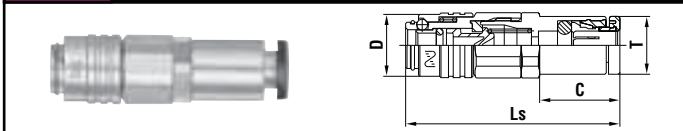

Model	Application (Tube)	Mass (g)	Dimensions (mm)			
			Ls	øD	C	øT
MC-04SC	4mm OD	9	(31.5)	9.5	(11.8)	8
MC-06SC	6mm OD	11.5	(33.5)	9.5	(12.5)	9.8

Plug PCL type (With L-shaped Tube Fitter)

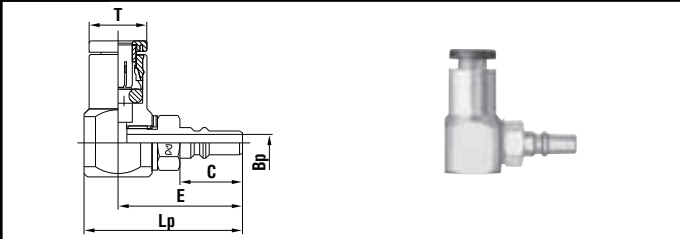

Model	Application (Tube)	Mass (g)	Dimensions (mm)				
			Lp	C	E	øT	øBp
MC-04PCL	4mm OD	10	(23.3)	9.2	(18.3)	8	2.5
MC-06PCL	6mm OD	13.5	(24.3)	9.2	(18.8)	9.8	2.5

Socket SCL type (With L-shaped Tube Fitter)

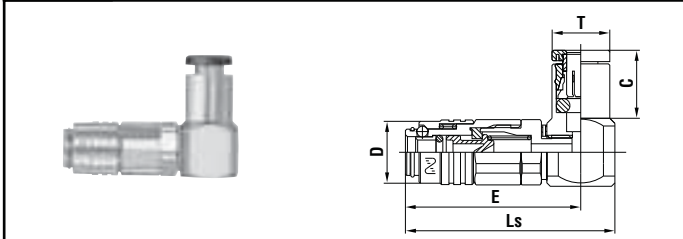

Model	Application (Tube)	Mass (g)	Dimensions (mm)				
			Ls	E	øD	C	øT
MC-04SCL	4mm OD	16	(30.8)	(25.8)	9.5	(10)	8
MC-06SCL	6mm OD	19	(31.8)	(26.3)	9.5	(12.5)	9.8

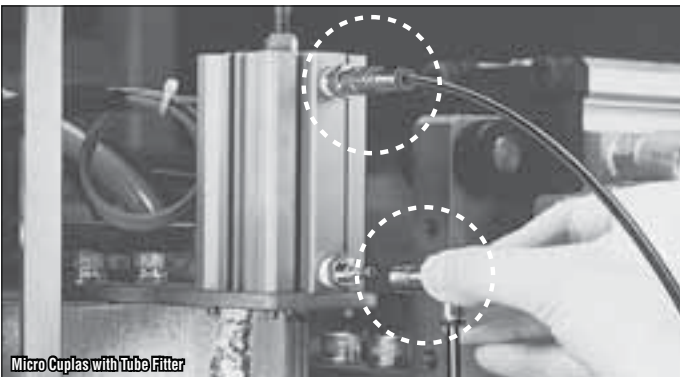

Socket SCB type (With Tube Fitter for panel mounting)

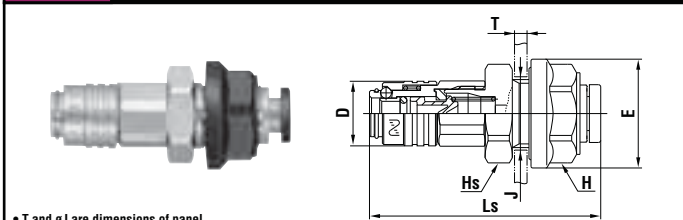

• T and øJ are dimensions of panel.

Model	Application (Tube)	Mass (g)	Dimensions (mm)						
			Ls	øD	øE	Hs(WAF)	H(WAF)	T	øJ
MC-04SCB	4mm OD	15	(34)	9.5	16	Hex.13	Hex.13	3.5 or less	10.5 ^{+0.3} ₀
MC-06SCB	6mm OD	18.5	(36)	9.5	18	Hex.15	Hex.15	3.5 or less	12.5 ^{+0.3} ₀

Socket Micro Line Cupla with three branch ports

• The branch body is made of aluminum alloy.

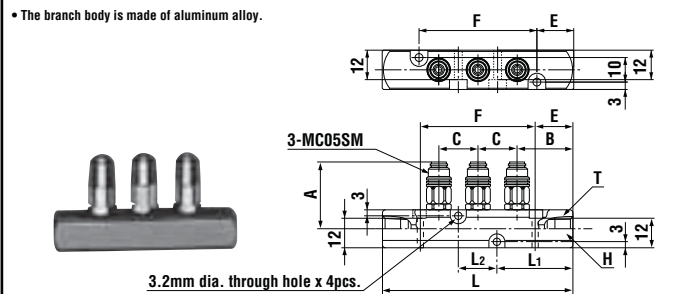

Model	Application	Mass (g)	Dimensions (mm)									
			L	L1	L2	A	B	C	E	F	T	H(WAF)
MC-03	3 ports	65	78	31	16	(28.8)	23	16	15	48	2-Rc1/8	Box 16

Socket Micro Line Cupla with 5 branch ports

• The branch body is made of aluminum alloy.

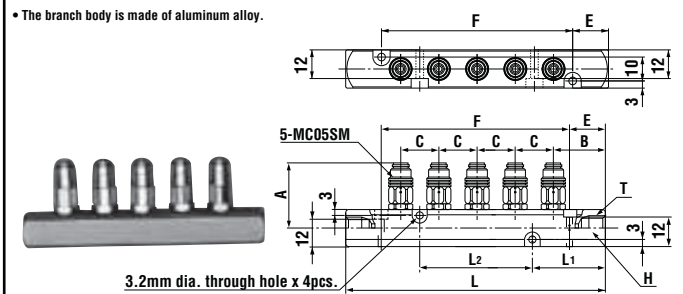

Model	Application	Mass (g)	Dimensions (mm)									
			L	L1	L2	A	B	C	E	F	T	H(WAF)
MC-05	5 ports	101	110	31	48	(28.8)	23	16	15	80	2-Rc1/8	Box 16

Socket Micro Line Cupla with 10 branch ports

• The branch body is made of aluminum alloy.

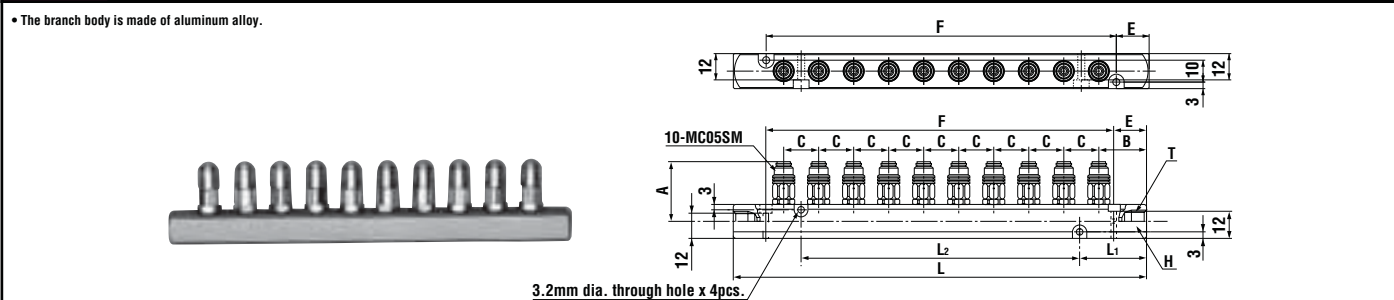

Model	Application	Mass (g)	Dimensions (mm)									
			L	L1	L2	A	B	C	E	F	T	H(WAF)
MC-10	10 ports	187	190	31	128	(28.8)	23	16	15	160	2-Rc1/8	Box 16

Micro Cupla

NEW Stainless steel models

Highly corrosion-resistant stainless steel Micro Cupla

Built-in automatic shut-off valve

9.5mm OD sleeve

Push-to-connect design

Wide variety of end configurations

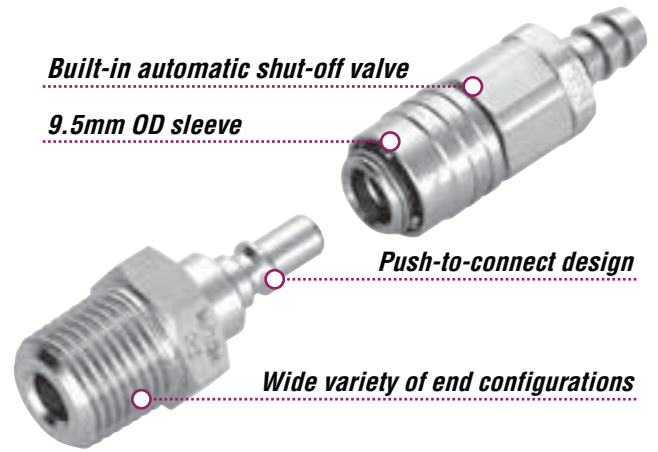

Models and Dimensions (Stainless Steel)

WAF : WAF stands for width across flat.

Plug PH type (Hose barb)

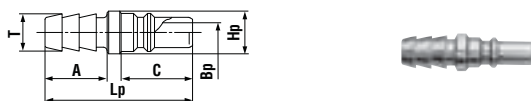

Model	Application (Tube)	Body material*Mass (g)	Dimensions (mm)					
		Stainless steel	Lp	C	A	øHp	øT	øBp
MC-04PH	4mm ID	1.3	19	9.2	8	5.5	4.8	2.5

Socket SH type (Hose barb)

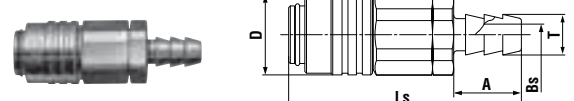

Model	Application (Tube)	Body material*Mass (g)	Dimensions (mm)				
		Stainless steel	Ls	øD	A	øT	øBs
MC-04SH	4mm ID	6.7	(27.5)	9.5	8	4.8	2.5

Plug PM type (Male thread)

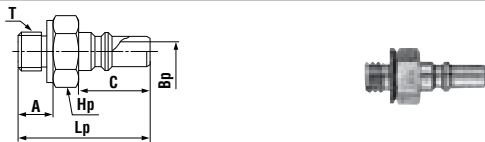

Model	Application	Body material*Mass (g)	Dimensions (mm)					
		Stainless steel	Lp	C	A	Hp(WAF)	T	øBp
MC-05PM	M5 x 0.8	2.2	17	9.2	4.5	Hex.8	M5x0.8	2.5

Socket SM type (Male thread)

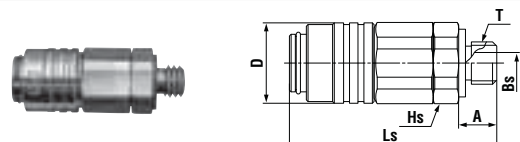

Model	Application	Body material*Mass (g)	Dimensions (mm)					
		Stainless steel	Ls	øD	A	T	Hs(WAF)	øBs
MC-05SM	M5 x 0.8	6.8	(24.5)	9.5	4.5	M5x0.8	Hex.9	2.5

Plug PM type (Male thread)



Model	Application	Body material*Mass (g)	Dimensions (mm)					
		Stainless steel	Lp	C	Hp(WAF)	T	øBp	
MC-10PM	Rc1/8	8.1	26	9.2	Hex.11	R1/8	2.5	

Socket SM type (Male thread)

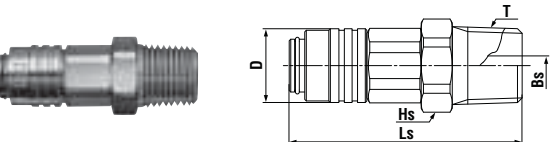

Model	Application	Body material*Mass (g)	Dimensions (mm)				
		Stainless steel	Ls	øD	T	Hs(WAF)	øBs
MC-10SM	Rc1/8	12.1	(30)	9.5	R1/8	Hex.11	3

Plug PHL type (L-shaped hose barb)

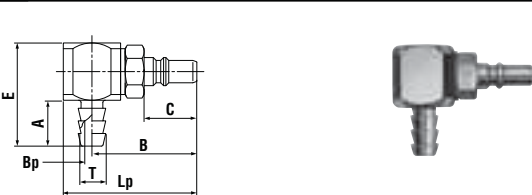

Model	Application (Tube)	Body material*Mass (g)	Dimensions (mm)						
		Stainless steel	Lp	C	A	B	E	øT	øBp
MC-04PHL	4mm ID	9	(23.3)	9.2	8	(18.3)	18	4.8	2.5

Socket SHL type (L-shaped hose barb)

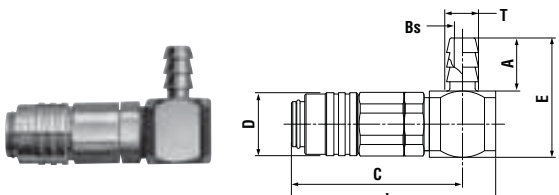

Model	Application (Tube)	Body material*Mass (g)	Dimensions (mm)						
		Stainless steel	Ls	C	E	A	øD	øT	øBs
MC-04SHL	4mm ID	13.6	(30.8)	(25.8)	18	8	9.5	4.8	2.5

Socket SHB type (For panel mounting)

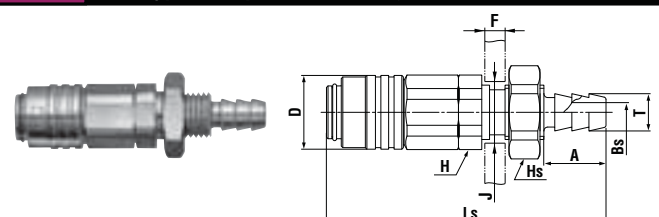

* F and øJ are dimensions of panel.

Model	Application (Tube)	Body material*Mass (g)	Dimensions (mm)									
		Stainless steel	Ls	A	øD	øT	øBs	Hs(WAF)	øJ	H(WAF)	F	
MC-04SHB	4mm ID	10.6	(36)	8	9.5	4.8	2.5	Hex.11	7.1 ^{+0.3} ₀	Hex.9	1.2-3.5	

Before use, please be sure to read "Safety Guide" described at the end of this book and "Instruction Sheet" that comes with the products.