

# Pallet truck scale KERN VHB



## Transportation and weighing in one operation

### Features

- PRE-TARE function for manual subtraction of a known container weight, which can be saved
- **1** Display device: IP65. Protected against dust and water splashes
- **2** Load area: IP67. Load cells are protected against dust and water, designed for temporary use in wet areas
- Pivot range 206°, solid rubber castors on aluminium rims
- **3** Tandem tyres on load rollers so that you can get over thresholds and obstacles more easily

- Ready for use: Batteries included (4x 1,5V AA). AUTO-OFF function to preserve the battery. Operating time approx. 80 h/1700 weighings. Charge condition indicator on display

### Options

- **4** Footbrake to lock solid rubber castors, **KERN VHB-A01**

### Technical data

- Large LCD display, digit height 28 mm

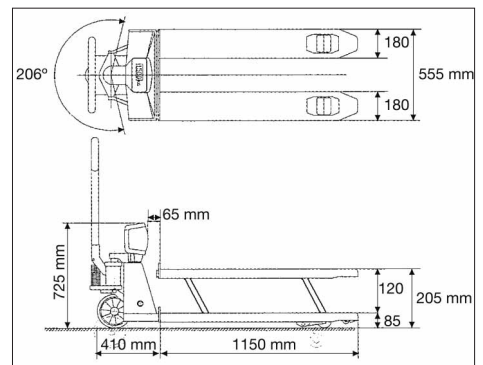

12

#### STANDARD

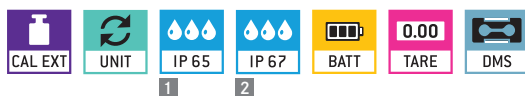

#### STANDARD

























#### OPTION



Model	Weighing range	Readout	Net weight approx.	Permissible ambient temperature °C	Option	
					DKD Calibr. Certificate	DKD KERN
KERN VHB 2T1	[Max] kg 2000	[d] kg 1	kg 120	-10°C / 40°C	963-131	

# KERN Pictograms

 <b>Internal adjusting (CAL):</b> Quick setting of the balance's accuracy with internal adjusting weight (motordriven).	 <b>Adjusting program (CAL):</b> For quick setting of the balance's accuracy. External adjusting weight required.	 <b>Weighing units:</b> Can be switched to e.g. non-metric units at the touch of a key. See balance model. Please refer to KERN's website for more details.
 <b>Rechargeable battery pack:</b> rechargeable set.	 <b>Power supply:</b> integrated in balance. 230V/50Hz in Germany. On request GB or USA version.	 <b>Mains adapter:</b> 230V/50Hz in standard version for Germany. On request GB or USA version.
 <b>Battery operation:</b> The battery type is specified for each device.	 <b>Piece counting:</b> Reference quantities selectable. Display can be switched from piece to weight	 <b>Spray and dust protection IPxx</b> The type of protection is shown by the pictogram. For details see the glossary.
 <b>Data interface:</b> The type of interface is shown by the pictogram. See the glossary for further details.	 <b>GLP/ISO record keeping</b> of weighing data with date, time and identification-no. Only with printers from KERN.	 <b>Tare:</b> put back displayed value to "0" during weighing process, e.g. to add or remove weighing material from a container.
 <b>Animal weighing program:</b> Strong vibrations are filtered out to determine a stable weighing result.	 <b>Stainless steel:</b> the balance is protected against corrosion.	 <b>Warranty:</b> The warranty period is shown in the pictogram.
 <b>Net-total weighing:</b> weight of tare cup and weight of components memorized in two separate stores.	 <b>Suspended weighing:</b> load support with hook on the underside of the balance.	 <b>Verification possible.</b> The time required for verification is specified in the pictogram.
 <b>Percentage determination:</b> Displays the deviation from the reference weight (100%) in % instead of grams.	 <b>Weighing with tolerance range:</b> Upper and lower limiting can be programmed individually, e.g. dosing/sorting.	 <b>DKD calibration possible.</b> The time required for DKD calibration is specified in the pictogram.
 <b>Package shipment</b> via courier.	 <b>Pallet shipment</b> via freight forwarder.	<b>[DMS]</b> For details on weighing technologies, see the glossary.

## Precision is our business

To ensure the high level of precision of your balance, KERN offers the appropriate test weight package for your balance. This consists of the test weight, box and DKD calibration certificate, as proof of its accuracy. The best way to ensure proper balance calibration.

In the extensive KERN test weight range, you will find test weights in the international OIML error limit classes: E1, E2, F1, F2, M1, M2, and M3 with weights from 1 mg to 2000 kg.

The KERN DKD calibration laboratory for electronic balances and weights has been accredited by DKD since 1994 and today is one of the most modern and best-equipped DKD calibration laboratories for balances, test weights and force-measurement in Europe.  
(DKD = German Calibration Service)

Thanks to the high level of automation, we can carry out DKD calibration of balances, test weights and force-measuring devices 24 hours a day, 7 days a week.

### Range of services:

- DKD calibration of balances with a maximum load of up to 6 t
- DKD calibration of weights in the range of 1 mg – 500 kg
- Database supported management of checking equipment and reminder service
- Calibration of force-measuring devices
- DKD calibration certificates in the following languages  
D, GB, F, I, E, NL, PL

Do you have questions about your scale, the corresponding test weight or the calibration service? Your KERN specialist dealer will be pleased to assist you.

## Your KERN specialist dealer:

**KERN – Professional measuring. Measuring technology and testing services from a single source**



German Excellence Group  
Member